

DIGifactor club 6x2,5Kw

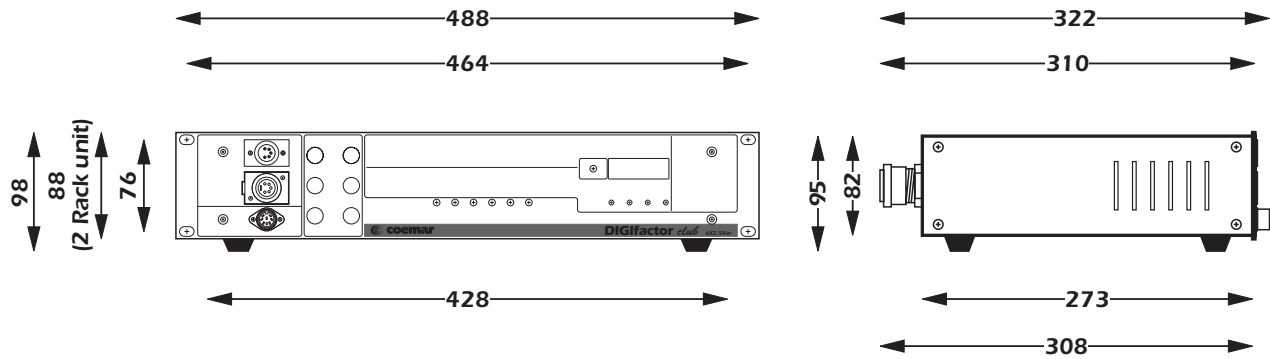

serial number

date of purchase

retailer

address

suburb

capital city

state

tel./fax/

Please note in the space provided above the relative service information of the model and the retailer from whom you purchased your **DIGifactor club 6x2,5Kw**: This information will assist us in providing spare parts, repairs or in answering any technical enquiries with the utmost speed and accuracy.

WARNING: the security of the fixture is granted only if these instructions are strictly followed; therefore it is absolutely necessary to keep this manual.

Index

- 1. Introduction**
- 2. Technical characteristics**
- 3. Mechanical installation**
- 4. Connection to mains power**
- 5. Load connection**
- 6. Signal connection**
 - 6.1 DMX 512**
 - 6.2 0/+10VDC**
- 7. Powering up**
- 8. DMX addressing or analogue 0/+10v DC**
 - 8.1 0/+10V DC**
 - 8.2 DMX 512**
- 9. Display panel functions**
 - 9.1. Test**
 - 9.1.1. Testing individual channels**
 - 9.2 Electrical and electronic displays**
 - 9.2.1. Voltage**
 - 9.2.2. Frequency**
 - 9.2.3. Temperature**
 - 9.2.4. DIGIfactor *club* 6x2,5Kw hours of operation**
 - 9.2.5. DMX 512 parameter displays**
 - 9.2.6. Individual channel DMX 512 input signal levels**
 - 9.2.7. Individual channel 0/+10V DC input signal levels**
 - 9.2.8. Instantaneous output voltage measurement on every channel**
 - 9.3 Advanced functions (installer options)**
 - 9.3.1. Lamp pre-heating**
 - 9.3.2. Setting individual channel output voltage limits**
 - 9.3.3. Setting channels to on/off operation (switching)**
 - 9.3.4. Switching channels - pre-heating**
 - 9.3.5. Setting dimming curves**
 - 9.3.6. Recording output levels**
 - 9.3.7. Restoring scenes from back-up**
 - 9.3.8. Overheating protection**
 - 9.3.9. DIGIfactor *club* 6x2,5Kw resetting**
 - 9.3.10. Viewing recorded scenes**
 - 9.3.11. Switching off pre-recorded scenes**
- 10. Remote back-up scene restoration**
- 11. Error messages**
- 12. Maintenance**
- 13. Spare parts**

Coemar authorised services centres worldwide

1. Introduction

Congratulations on having purchased a new **coemar** product. You have ensured yourself of a controller of the highest quality, both in the components and in the technology used.

In any request for information regarding the **DIGifactor club 6x2,5Kw**. We ask that you specify correctly the model purchased. To this end we request that you complete the purchase details listed below. This information will assist us in providing you with prompt and accurate information.

2. Technical characteristics

DIGifactor club 6x2,5Kw is a dimmer rack allowing control over the output of 6 channels from 0 to 230V. The six channels may be loaded to a maximum of 2,5KW; therefore resulting in a maximum current of 10 Amps per channel.

mechanical:

- Removeable enclosure panels allow easy internal inspection
- Maximum ambient operating temperature: 40 °C
- Weight: 7,5 Kg.

electrical:

- Power supply 230V three phase + N + E
- Voltage over-supply protection
- Load protection via ceramic fuses
- Maximum load per channel: 2,5KW
- Number of channels: 6.
- CE compliance
- Locking load connectors
- Locking supply connectors
- Fuse-blown indicator on all load outlets

electronics:

- Load voltages controlled by either 0/+10 v DC or DMX 512 signal
- Single channel test facility
- Digital DMX 512 addressing.
- Internal measurement of each of the three phases
- Internal measurement of supply frequency
- Instantaneous internal temperature measurement at the triacs
- Hours of operation counter
- DMX parameter measurement and display
- Individual channel pre-heating
- Variable maximum output limits for each channel
- Individual channels assignable as dimming or switching (on/off)
- Individual switching channel pre-heating(for transformer loads).
- 9 scenes programmable in the **DIGifactor club 6x2,5Kw** for use in absence of a control console
- Reset function
- DMX 512 via XLR 5/M socket
- Daisy chaining of **DIGifactor club 6x2,5Kw** and other DMX 512 units via XLR 5/F plugs
- Internal +20 V DC powersupply
- 0/+10V DC via 8 pin Locking din
- 0-10 and DMX signal input measurement
- Output voltage display

3. Mechanical installation

Installation into a rack-case or a fixed installation should follow certain procedures to ensure correct operation of the unit.

Attention!

DIGifactor club 6x2,5Kw is mechanically constructed to suit standard 19" rack mounting

Load voltage regulation is via internally mounted Triacs; these components will heat up when a load is connected; the **DIGifactor club 6x2,5Kw** needs to dissipate this heat and for this reason the unit needs to be located in a well-ventilated position, leaving a minimum of 2 centimetres clearance around the unit housing and any adjoining surfaces.

Note that on either side of the **DIGifactor club 6x2,5Kw** there are forced-cooling air intake/exhaust passages. These passages should under no circumstances be covered.

Installation should not be onto a flammable surface; a hot housing is indicative of abnormal operating conditions.

Ambient operating temperature range: -10°C to +40°C.

If the ambient operating temperature exceeds that indicated, you may choose to install a forced-air cooling system into your **DIGifactor club 6x2,5Kw** rack case or mounting system to remove hot air from the housing.

After having installed the **DIGifactor club 6x2,5Kw** refer to section 9.2.3 of this manual, "Temperature testing" to complete the correct installation of the unit.

Note that maximum operating temperature should be measured only after all load has been connected and been operating for a minimum of one hour.

4. Connection to mains power

DIGifactor club 6x2,5Kw is a dimmer rack suitable for power supply via 3 phase 230V.

230V single phase supply is possible, but will not allow the unit to be used in adherence to certain safety norms concerning electrical operation and electromagnetic radiation emission.

Strict adherence to local regulatory requirements is essential; as is a correct and secure earth connection.

Ensure the supply cable is able to carry the maximum load for the unit.

- 1) Loosen the four screws **(A)** which affix the rear panel **(B)**.
- 2) Locate the power supply terminal strip
- 3) Slide your supply cable through the cable clamp till sufficient length is available for connection to the terminal strip.
- 4) Fix the cable clamp to the cable securely.

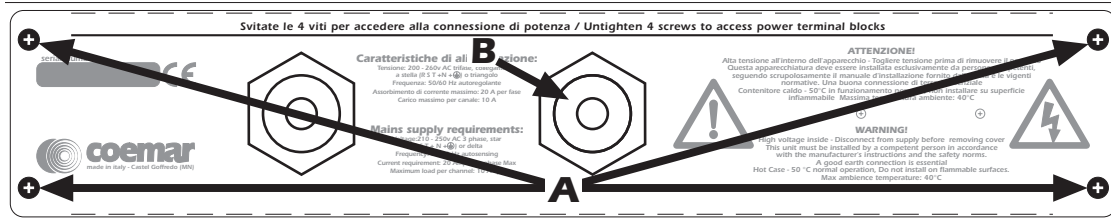

- 5) Connect the cable as shown in the diagram.

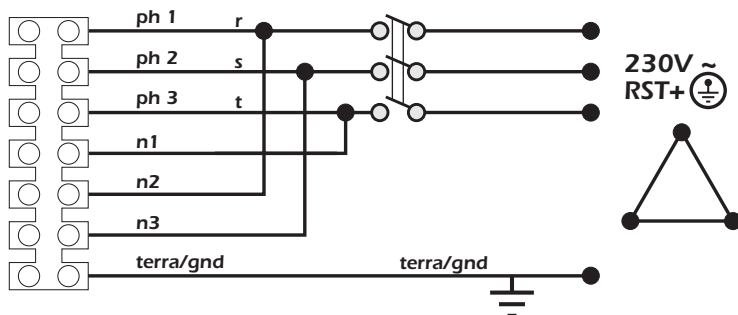
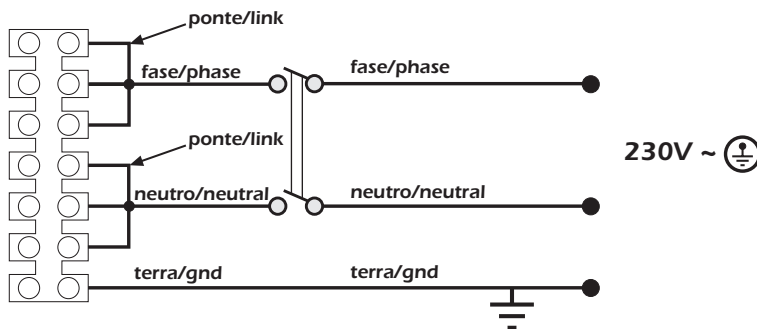
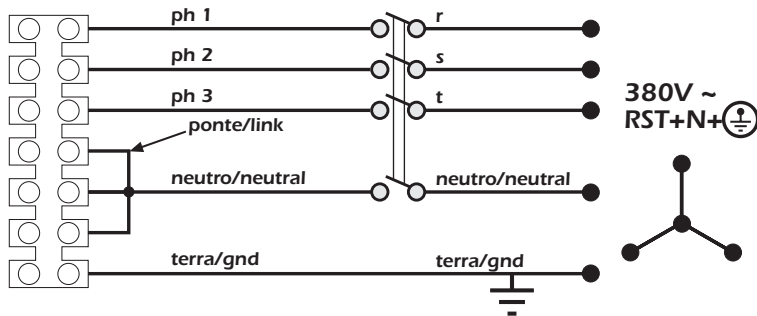

protection

For proper powering up of the **DIGifactor club 6x2,5Kw** we recommend the use of a thermal/magnetic circuit breaker of sufficient rating, as indicated in the diagram.

Attention

DIGifactor club 6x2,5Kw is a high-technology dimmer running on mains power; only qualified personal should perform installation, after thorough examination of this manual, and bearing in mind all local norms. Remove mains power prior to removing the rear panel and performing any internal procedures.

The housing may be hot, 50°C during normal operation, do not install on flammable surfaces. Maximum ambient temperature: 40°C

5. Load connection

DIGifactor club 6x2,5Kw can control a maximum of 6 channels @ 2,5 Kw; with a maximum of 10 Amps per channel.

Do not overload the outlets!

Refer to local regulations and norms with respect to the correct cabling required for connection of loads to dimmers in public locations.

A good and secure earth connection is essential.

- 1) Loosen the four screw (A) on the rear panel (B) of the **DIGifactor club 6x2,5Kw**; using a cable of suitable rating slide it through the cable clamp (C) located on the rear of the unit and secure it firmly.

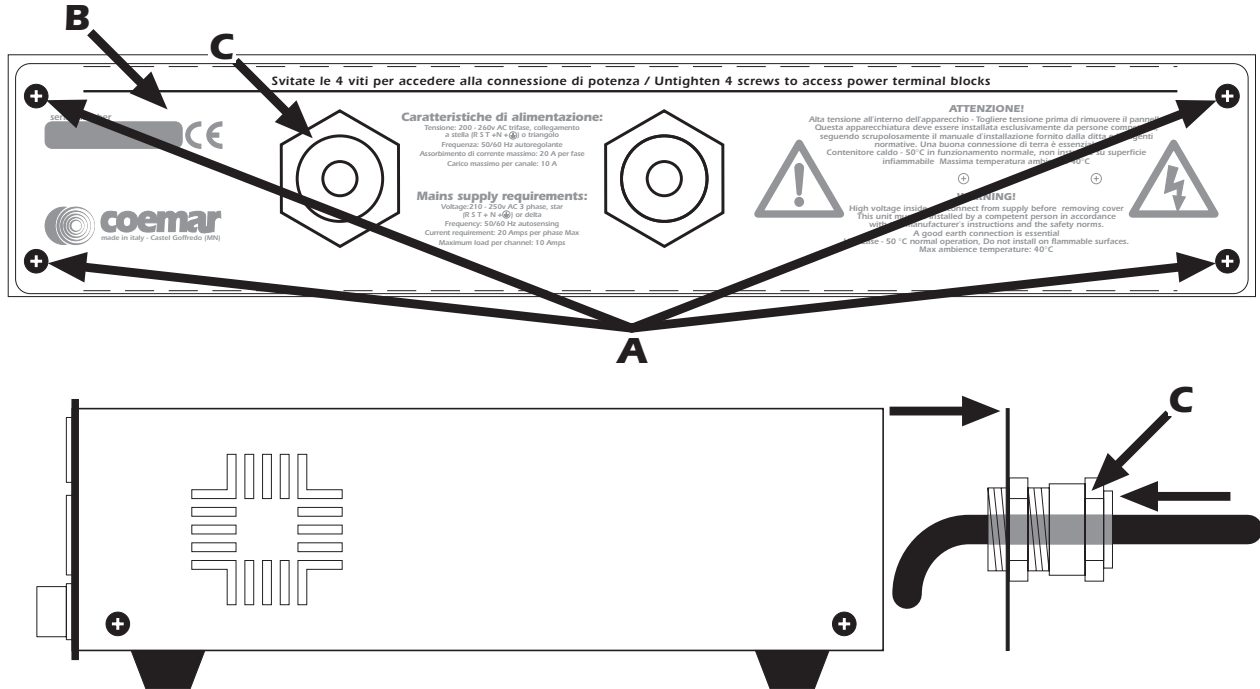

- 2) Connect the load cables, referring to the schematic shown, where a standard load is indicated by lamps.

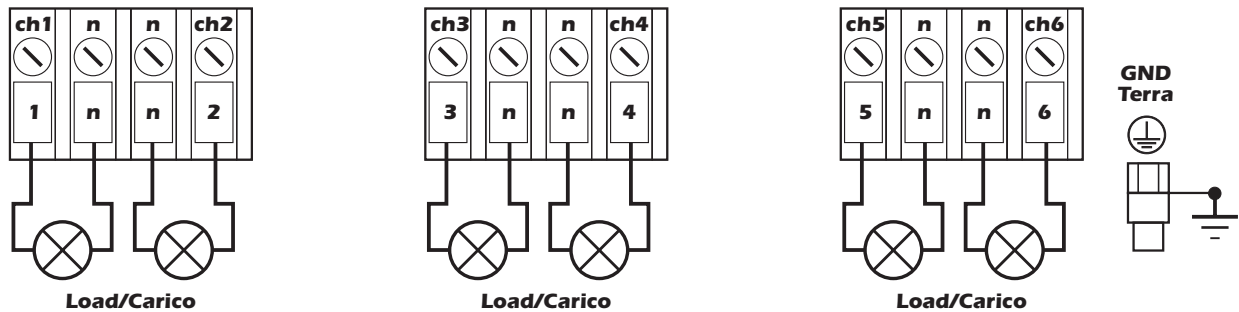

- 3) Re-close the rear of the **DIGifactor club 6x2,5Kw**.

6. Signal connection

DIGifactor club 6x2,5Kw operates on the two most common control signals used in the lighting industry: digital DMX 512 and analogue 0/+10V dc.

6.1 DMX 512

DIGifactor club 6x2,5Kw receives, via an XLR 5 plug, 6 channels of DMX 512 digitally addressed as 1 to 6; using the signals to control the output levels of 6 channels in the range of 0 to 255, as per the DMX 512 standard, regulated by USITT (U.S Institute of Theatre Technology)

Connection between the DMX 512 controller and the **DIGifactor club 6x2,5Kw** follows the recognised standard:

Pin 1= Ground (GND)

Pin 2= DATA -

Pin 3= DATA +

Pin 4= Optional - (not connected)

Pin 5= Optional + (not connected)

If required, the components for making up cables are available from **coemar**:

ME 4966 (Plug XLR 5)

ME 4965 (Socket XLR 5)

CV 4158 (two core screened cable Ø 0.5)

Connection should be via two core screened cable, following all protocols for screened signal cable.

Screening is always connected to pin 1 of the XLR plug and must be isolated from the metallic housing of the plug, with regards to polarity.

A typical DMX 512 connection with **DIGifactor club 6x2,5Kw** is shown in the diagram.

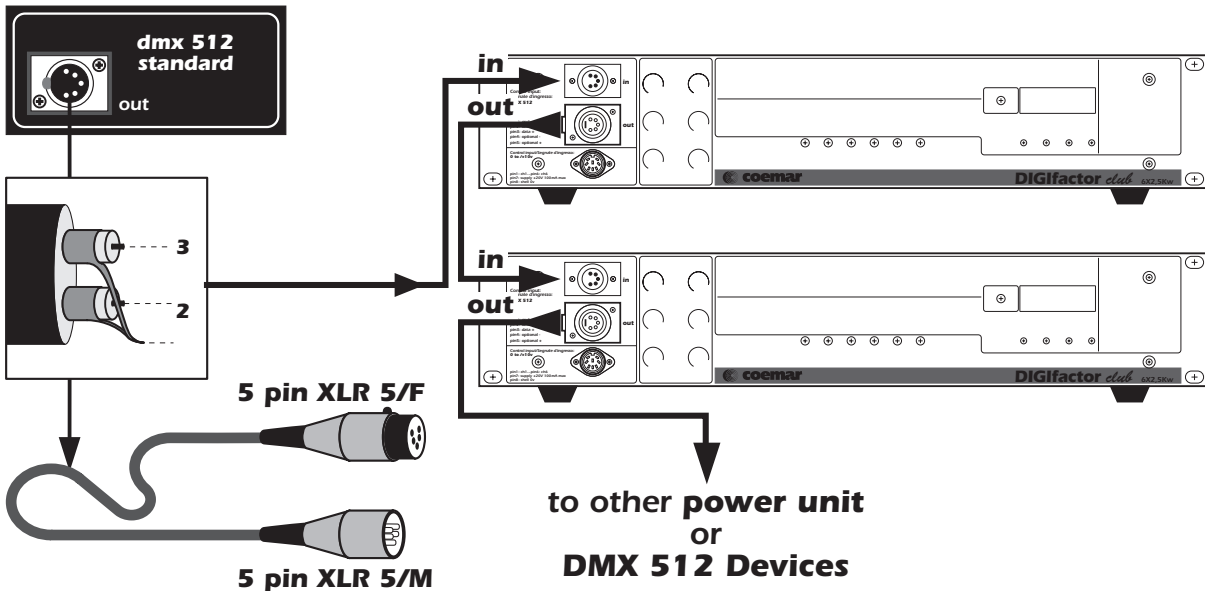

6.2 0/+10VDC

DIGifactor club 6x2,5Kw receives via a Locking-din plug, 6 variable voltages from 0 to +10V continuous current, as per international norms for analogue transmission.

Connection is particularly simple if the fixture receiving signal follows the **coemar** standard

Plug type Locking din 8 pin **DIGifactor club 6x2,5Kw**

Pin 1= 0/+ 10 V DC channel 1

Pin 2= 0/+ 10 V DC channel 2

Pin 3= 0/+ 10 V DC channel 3

Pin 4= 0/+ 10 V DC channel 4

Pin 5= 0/+ 10 V DC channel 5

Pin 6= 0/+ 10 V DC channel 6

Pin 7= supply + 20 V DC

Pin 8= 0V DC reference

Pin number 7 is connected to an internal +20 V DC regulated power supply; this is useful as a power supply source for a number of consoles which operate on this voltage.

If the control console operates on the **coemar** standard, you may use the following locking din cables available from your authorised **coemar** service centre:

Code: 247 (5m length)

Code: 248 (10m length)

Code: 249 (25m length)

Code: 250 (50m length)

If required, compomts for the manufacture of cable can be ordered from **coemar**:

ME 261 (Locking-din plug)

CV 924 (screened 8 core cable Ø 0.25, per metre)

CV 4158 (8 core cable Ø 0.25, per metre)

We recommend the use of screened cable; particularly in situations where the possibility of electromagnetic disturbance is high, to reduce to a minimum the possible causes of incorrect functioning of equipment.

Screening should always be connected to pin 8 of the locking-din.

Shown is a typical 0/+10v DC connection between controller and **DIGifactor club 6x2,5Kw**.

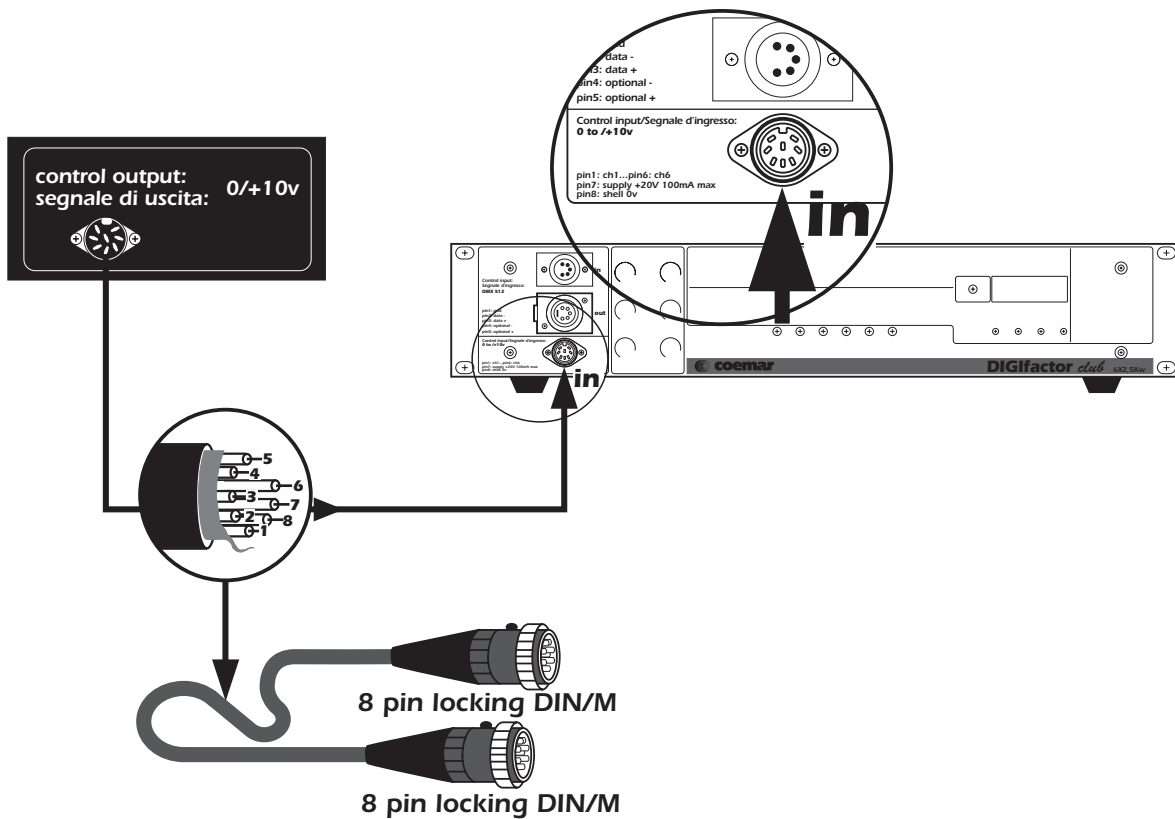

7. Powering up

After having carefully followed the instructions regarding electrical connection and mechanical fixing, the **DIGifactor club 6x2,5Kw** may now be powered up via an thermal/magnetic circuit breaker as described in section 4.

Upon powering up, the display will run through a test/reset procedure which begins with a display of the software version installed in the unit, followed by a measurement of the current operating frequency of the power supply and auto-optimisation of the unit's operation. **DIGifactor club 6x2,5Kw** will also display the voltage above 250V or below 180V. When the display shows A001 (or any other value preceded by the letter A), the **DIGifactor club 6x2,5Kw** is ready for normal operation.

Attention!

If the start-up procedure is not as described above, and the display does not come on, it may be that the power supply is not connected properly; refer to section 4 to re-check connection.

If the display should come on signaling other than that described above, refer to your authorised **coemar** service centre for further advice

8. DMX addressing or analogue 0/+10v DC

As described in section 6 you may use the **DIGifactor club 6x2,5Kw** with either 0/+10V DC or DMX 512 control signals; depending upon the requirements of your controller

8.1 0/10 v DC

After having correctly connected the cable, channel number 1 of the **DIGifactor club 6x2,5Kw** corresponds to the signal being sent via pin 1 of the Locking DIN; channel number 2 corresponds to the signal being sent via pin 2 of the Locking DIN, and so on until the 6th channel being via pin number 6 of the Locking DIN.
A variation in the voltage from 0 to 10 V of the control signal corresponds to a variation of the load voltage from 0 to 230 V.

8.2 DMX 512

After correct connection of the DMX 512 signal cable, the 6 channels of the dimmer are controlled via 6 channels of your DMX controller in sequence.

Upon first turning on the dimmer's display shows **A001** indicating the address **DMX 1**.

A dimmer so addressed will respond to channels **1** through **6** of the **DMX 512** controller, a second dimmer should be addressed as **7**, and so on in multiples of 6.

A dimmer can therefore respond to whichever 6 sequential channels of the controller you wish simply by changing the display's address.

Note that after the first address is set, **DIGifactor club 6x2,5Kw** will also occupy the next 5 addresses as well.

changing the dmx address

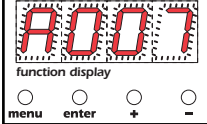
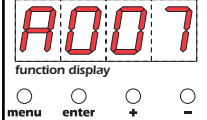
Power up the DIGifactor club 6x2,5Kw		Address DMX 001
Press the + or - buttons until the desired channel is shown		Shows the DMX addresses from 1 to 501, the led display will flash, indicating that the change has not been recorded yet, for example, 7
Press the enter button		PConfirms your selection of address, the display stops flashing and the unit responds to the new DMX 512 address.

Important Note: Keeping the **+** or **-** buttons depressed will cause the display to scroll at high speed, allowing for rapid changing.

The presence of DMX signal is indicated by the flashing led in the DMX input display.



9. Display panel functions

Attention! the display panel controls the proper functioning of the dimmer and its various parameters.

Altering the **coemar** factory presents can vary the functioning of the dimmer, causing it to not respond to **DMX 512** control signal; careful and thorough reading of all the following procedures is therefore recommended prior to altering any functions.

IMPORTANT NOTES: these notes are valid for all the functions which follow

1. Keeping the **+** or **-** buttons depressed for 8 seconds for rapid scrolling.
2. You may abort the altering of any function by simply pressing the **menu** button until the display shows the DMX address
3. To immediately go to the maximum value, press the **+** button whilst simultaneously pressing the **-** button.
4. To immediately go to the minimum value, press the **-** button whilst simultaneously pressing the **+** button.
5. You may alter single channel settings or press the **+** or **-** buttons until the display shows **ALL** to alter all channels simultaneously.
6. Changes made via the menu buttons are confirmed and recorded when the **enter** button is pressed.
It is always possible to over-write any settings with new ones at any time.
The reset procedure allows all settings to be returned to factory presets, with the exception of the DMX address.
7. Display panel functions remain active for 10 seconds if no changes are made, after which they will return to the DMX address display/

The display panel has three menus and main functions, which are:

9.1. Test

9.2. Electrical and electronic displays

9.3. Advanced functions (installer options)

9.1. Test

9.1.1. Tests every channel

Allows the testing of every outlet of the **DIGifactor club 6x2,5Kw**, without the need for a controller

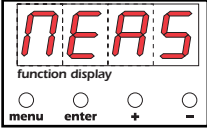
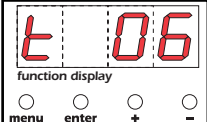
Power up the DIGifactor club 6x2,5Kw		Address DMX 001
Press the menu button		electronics display menu
Press the + button		Channel test menu
Press the enter button		To confirm your selection of channel test , the first channel for testing is displayed as 1 (t 01).
Press the + or - buttons to select the required channel for testing		For example, test channel 6 (t 6)

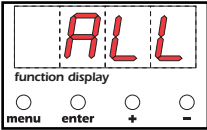
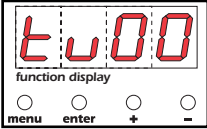
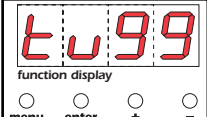

You may repeat the test on any individual channel, or, alternatively:

Press the + or - buttons		ALL to test all channels simultaneously
Press the enter button		Output level set to 00
Press the + or - button		Select an output level from 0 to 99 (maximum output); via the digital display. As the display value increases, note that the output level of the load does the same.

9.2 Electrical and electronic displays

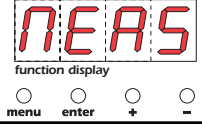

9.2.1. Voltage display

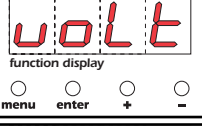
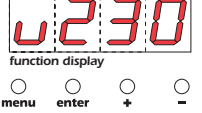
Displays the input voltage across the three phases (in volts).

Power up DIGifactor club 6x2,5Kw		DIGifactor club 6x2,5Kw turns on
Press the menu button		Electronic display menu
Press the enter button		To confirm your selection
Press the + or - buttons		voltage displayed
Press the enter button		DIGifactor club 6x2,5Kw measures the voltage across one phase, for example phase 1 voltage is 230v

9.2.2. Frequency display

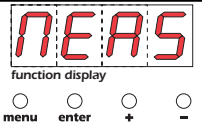
Displays the input voltage frequency (in Hertz).

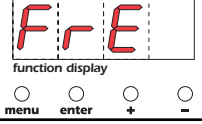
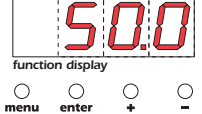
Power up DIGifactor club 6x2,5Kw		DIGifactor club 6x2,5Kw turns on
Press the menu button		Electronic display menu
Press the enter button		To confirm your selection
Press the + or - button		FrE measures the frequency in Hertz
Press the enter button		DIGifactor club 6x2,5Kw FrE measures the frequency in Hertz

9.2.3. Temperature display

Displays the instantaneous temperature of the dimmer's internals (in centigrade).

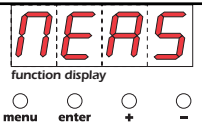
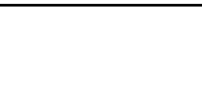
Power up DIGifactor club 6x2,5Kw		DIGifactor club 6x2,5Kw turns on
Press the menu button		Electronic display menu
Press the enter button		To confirm your selection

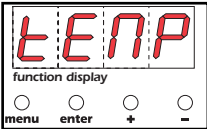
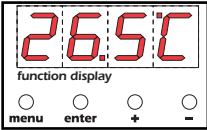

Press the + or - buttons		tEMP temperature display in °C
Press the enter button		DIGifactor club 6x2,5Kw displays the temperature, measured at the triacs

The maximum operating temperature of the unit is 65°C. If under full load for some hours the temperature should exceed 65°, re-check the mechanical installation of the unit, which may be incorrect. The forced cooling system may be obstructed, the fan itself may be functioning incorrectly; or simply the unit's cooling system may not be situated in a suitable position to allow heat to be dissipated sufficiently.

In such an instance, the addition of a further fan at the base of the unit, may be appropriate.

9.2.4. DIGifactor club 6x2,5Kw hours of operation

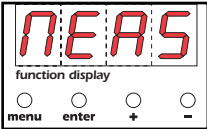
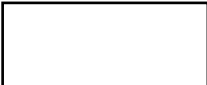
Displays the number of hours that the **DIGifactor club 6x2,5Kw** has been operated (in hours)

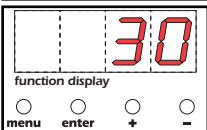
Power up DIGifactor club 6x2,5Kw		DIGifactor club 6x2,5Kw turns on
Press the menu button		Electronic menu display
Press the enter button		To confirm your selection
Press the + or - button		HoUr display in hours
Press the enter button		DIGifactor club 6x2,5Kw displays the amount of time, in hours, it has been operational, for example, 30.

9.2.5. DMX 512 parameters display

Displays significant parameters of the **DMX 512** signal, bringing any problems to light

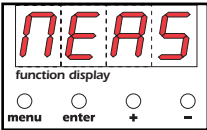
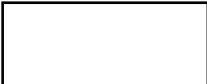
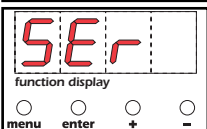
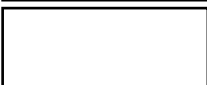
Power up DIGifactor club 6x2,5Kw		DIGifactor club 6x2,5Kw turns on
Press the menu button		Electronic display menu
Press the enter button		To confirm your selection
Press the + or - button		SEr displays significant parameters of the DMX 512 signal
Press the enter button		To confirm your selection

You may now display various DMX 512 parameters

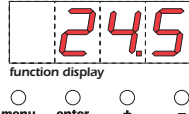
Press the + or - button		rAtE measures the frequency at which DIGifactor club 6x2,5Kw receives a new packet of signal (DMX)
Press the enter button		DIGifactor club 6x2,5Kw displays the value in Hertz

Recommended values: Minimum 1, maximum 44 Hz.
or

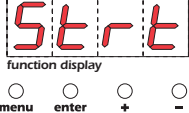
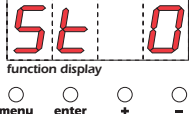
Press the + or - button		Strt the first bit after a reset signal (DMX)
Press the enter button		DIGifactor club 6x2,5Kw displays the reading

Refer to section 12 for information regarding error messages

9.2.6. Individual channel DMX 512 input signal levels

Displays the DMX level (from 0 to 255) which is being outputted by the controller to each of the 6 channels

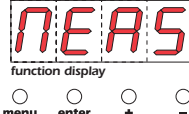
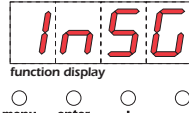
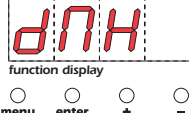
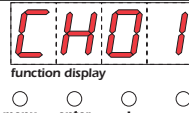
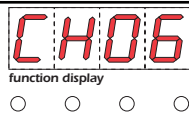
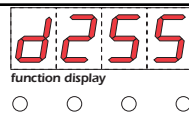
Power up DIGifactor club 6x2,5Kw		DMX address
Press the menu button		Electronic display menu
Press the + or - button until InSG is displayed		Input signal display menu
Press the enter button		To confirm your selection
Press the + or - button until dmX is displayed		To measure the incoming DMX 512 signal levels
Press the enter button		Channel number 1
Press the + or - button to select the next channel you wish to display		For example, channel number 6
Press the enter button		DIGifactor club 6x2,5Kw will display the incoming DMX 512 signal level of the selected channel, for example a level of 255.

9.2.7. Individual channel 0/+10V DC input signal levels



Displays the 0/+10V DC level (decimal from 0 to 10) which is being outputted by the controller to each of the 6 channels

Power up DIGifactor club 6x2,5Kw		DMX address
Press the menu button		Electronic display menu
Press the + or - button until InSG is displayed		Input signal display menu
Press the enter button		Measure the incoming signal level
Press the + or - button until 0-10 is displayed		To measure the incoming 0/10V signal
Press the enter button		Channel number 1
Press the + or - button to select the next channel you wish to display		For example, channel number 6
Press the enter button		DIGifactor club 6x2,5Kw will display the incoming 0/+10v signal level of the selected channel, for example a level of 8 volts

9.2.8. Individual channel output voltage levels

Displays the instantaneous output level (in volts) of each of the 6 channels. The display may be the result of an output voltage as determined by the controller, or of an in-built function of the dimmer, such as swithing channel pre-heating.

Power up DIGifactor club 6x2,5Kw		DMX address
Press the menu button		Electronic display menu
Press the + or - button until Outv is displayed		Output voltage display menu
Press the enter button		To confirm your selection
Press the enter button		Channel number 1



Press the + or - button to select the next channel you wish to display	 <p>function display</p> <p>○ menu ○ enter ○ + ○ -</p>	For example, channel number 12
Press the enter button	 <p>function display</p> <p>○ menu ○ enter ○ + ○ -</p>	DIGifactor club 6x2,5Kw will display the RMS output voltage of the selected channel (in volts). For example, 230 volts.

9.3. Advanced functions (installer options)

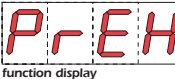
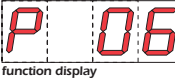
ATTENTION! Modifying these settings will modify the operation of the **DIGifactor club 6x2,5Kw**. Use these functions only when necessary.

Power up DIGifactor club 6x2,5Kw		DIGifactor club 6x2,5Kw turns on
Simultaneously press the menu and enter buttons	 <p>function display</p> <p>○ menu ○ enter ○ + ○ -</p>	Function menu displayed
Press the enter button		To confirm your selection
Press the + or - button	 <p>function display</p> <p>○ menu ○ enter ○ + ○ -</p>	To display the lamp pre-heat menu PrEH
Press the enter button		To confirm your selection
Press the + or - button until the required channel is selected	 <p>function display</p> <p>○ menu ○ enter ○ + ○ -</p>	For example, number 6

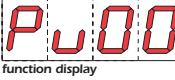
NOTE: ATTENTION! You may set individual pre-heat values for each channel or, by pressing the **+** or **-** buttons till **ALL** is displayed, you may address and set all the channels simultaneously

Press the enter button	 <p>function display</p> <p>○ menu ○ enter ○ + ○ -</p>	Pre-heating set at level 0
Press the + or - buttons until the required level is achieved.	 <p>function display</p> <p>○ menu ○ enter ○ + ○ -</p>	DIGifactor club 6x2,5Kw sets the dimmer channel(s) to the set minimum level, regardless of incoming DMX signal
Press the enter button		To set the level in memory

The voltage value selected above is calculated as a percentage of the input voltage, for ease of use. **DIGifactor club 6x2,5Kw** will display a value which is an approximation, not an accurate reading.

9.3.2. Setting individual channel output voltage limits





Sets a maximum output voltage (between the maximum output voltage and 180V) which the selected channel can achieve. Suitable if the dimmer is located close to the generator or sub-station by preventing lamp failure due to over-voltage supply.

Power up DIGifactor club 6x2,5Kw		DIGifactor club 6x2,5Kw turns on
Simultaneously press the menu and enter buttons		Function menu displayed
Press the enter button		To confirm your selection
Press the + or - button		Maximum output voltage menu displayed SEtv
Press the enter button		To confirm your selection
Press the + or - button to select the required channel		For example, channel 4
Press the enter button		Maximum output voltage is selected.
Press the + or - button		You may reduce the voltage down to 180V
Press the enter button		To confirm your selection

9.3.3. Setting channels to on/off operation (switching)

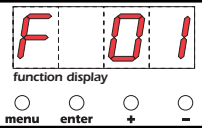

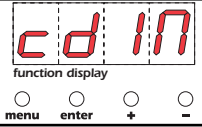
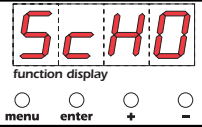
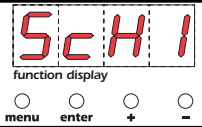

Allows selected channels to be set to on/off only. The channel will remain off up to 50% and on from 50% to 100%, it will not allow the voltage to be regulated to any other value.

Power up DIGifactor club 6x2,5Kw		DIGifactor club 6x2,5Kw turns on
Simultaneously press the menu and enter buttons		Function menu displayed
Press the enter button		To confirm your selection
Press the + or - buttons until FUnc is displayed		switching (on/off) or dimming menu is displayed

Press the enter button		To confirm your selection
Press the + or - buttons until the required channel is selected.		For example, channel 1
Press the enter button		To confirm your selection
Press the + or - button until cdiM is displayed		Dimmer function
Press the + or - button until ScH0 is displayed		Switching standard function
Press the + or - button until ScH1 is displayed		Transformer switching function (allows pre-heat to be assigned)
Press the enter button		To confirm your selection

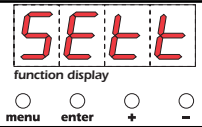
9.3.4. Switching channel pre-heating

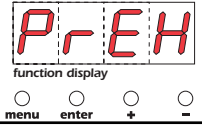
Causes sufficient voltage to be applied to the channel's load to assist in preventing lamp/transformer failure due to large thermal differences between fixture on and off states. You may select this function only if the channels have been set to switching **ScH1** as described above.

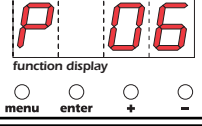
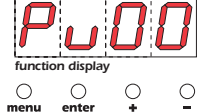
Power up DIGifactor club 6x2,5Kw		DIGifactor club 6x2,5Kw turns on
Simultaneously press the menu and enter buttons		Function menu displayed
Press the enter button		To confirm your selection
Press the + or - button until PrEH is displayed		Lamp pre-heating
Press the enter button		To confirm your selection
Press the + or - button until the required channel is selected		For example, channel 6 previously set to ScH1
Press the enter button		Pv00 pre-heat at level 0

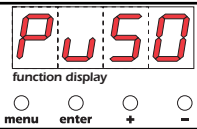
Press the + or - button until the required output voltage is achieved		DIGifactor club 6x2,5Kw sets the dimmer channel(s) to the set minimum level, regardless of incoming DMX signal
Press the enter button		To record the level in memory

9.3.5. Stting dimming curves

Allows the selection of two distinct dimming curves.

standard, a standard lighting response curve, where response to the control slider is proportional, thus resulting in the standard "S" type dimming curve.

lineare, a linear dimming curve where the response to the control slider is equal along the length of travel of the slider.

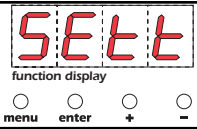
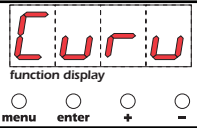
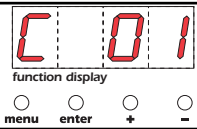
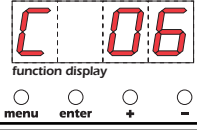
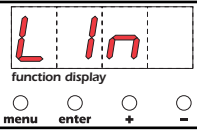
Power up DIGifactor club 6x2,5Kw		DMX address
Simultaneously press the menu and enter buttons		Function menu displayed
Press the enter button		To confirm your selection
Press the + or - buttons until Curv is displayed		Setting the type of dimming curve for each channel
Press the enter button		To confirm your selection
Press the enter button		Channel number 1
Press the + or - button until the required channel is selected		For example, channel number 6
Press the enter button		To confirm your selection
Press the + or - buttons until Strd is displayed		Setting the standard curve
Press the + or - buttons until Lin is displayed		Setting the linear curve
Press the enter button		To confirm your selection

oppure

9.3.6. Recording output levels

Allow the recording of up to 9 lighting scenes which may be played back at anytime without the need for an external play-back controller

Power up DIGifactor club 6x2,5Kw		DIGifactor club 6x2,5Kw turns on
Simultaneously press the menu and enter buttons		Function menu displayed
Press the enter button		To confirm your selection
Press the + or - buttons until Stor is displayed		Level recording
Press the enter button		To confirm your selection
Press the + or - buttons until the number of the required memory is displayed		For example, number 3
Press the enter button		DIGifactor club 6x2,5Kw reads the incoming signal, 0/+10V or DMX 512 . The display will flash to indicate that the recording is unconfirmed.
Press the enter button		To confirm your request to record the scene

9.3.7. restoring scenes from back-up

Allows a pre-recorded scene to be recalled and run via a remote signal, both from the mixer or an alternate source (see section 10 for connection details)

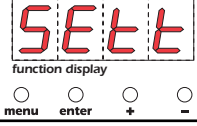
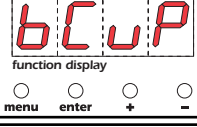
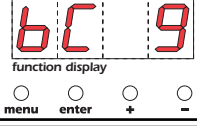
Power up DIGifactor club 6x2,5Kw		DMX address
Simultaneously press the menu and enter b		Function menu displayed
Press the + or - buttons until bCuP is displayed		Back-up activated
Press the enter button		To confirm your selection
Press the + or - buttons until the number of the required scene is displayed which you wish to restore via remote		For example, number 9 recorded previously
Press the enter button		To confirm your selection

9.3.8. Protection against over-heating

You may select the type of action which **DIGifactor club 6x2,5Kw** will effect in case it begins to overheat.

off: no protection

Pr 1: if the internal temperature exceeds 75 °C any channels previously set as dimming will lower their maximum output by up to 50% upon reaching 85 °C.

Any channels set as switching will be unaffected.

Pr 2: if the internal temperature exceeds 75 °C any channels previously set as dimming will lower their maximum output by up to 50% upon reaching 85 °C.

Any channels set as switching will be disabled.

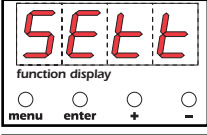
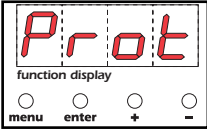
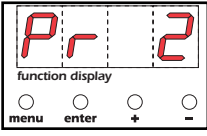
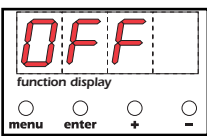
Power up DIGifactor club 6x2,5Kw		DMX address
Simultaneously press the menu and enter buttons		Function menu displayed
Press the + or - buttons until Prot is displayed		Protection menu
Press the + or - buttons until the type of protection desired is displayed		For example, Pr 2
Press the enter button		To confirm your selection
or		
Press the + or - buttons until OFF is displayed		Protection disabled
Press the enter button		To confirm your selection

9.3.9. Resetting DIGifactor club 6x2,5Kw

Allows the **DIGifactor club 6x2,5Kw** to reset all functions previously altered.

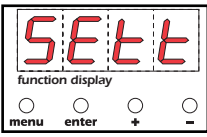
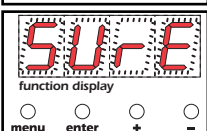
Power up DIGifactor club 6x2,5Kw		DIGifactor club 6x2,5Kw turns on
Simultaneously press the menu and enter buttons		Function menu displayed
Press the enter button		To confirm your selection
Press the + or - button until rESE is displayed		A reset of all altered functions, DIGifactor club 6x2,5Kw resets to the coemar factory presets
Press the enter button		The display flashes to indicate an unconfirmed reset. To escape at this point, without performing a reset, press the menu button

Press the enter button		DIGifactor club 6x2,5Kw performs a total reset of all functions.
-------------------------------	--	-------------------------------------------------------------------------

9.3.10. Viewing recorded scenes

Allows the 9 recorded scenes (as described above) without the need for an external controller.

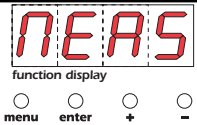
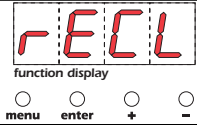
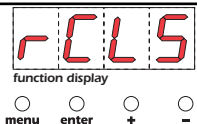
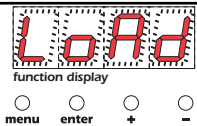
Power up DIGifactor club 6x2,5Kw		DIGifactor club 6x2,5Kw turns on
Press the menu button		Electronic display menu
Press the + or - buttons until rECL is displayed		To recall previously recorded scenes
Press the enter button		To confirm your selection
Press the + or - buttons until a previous recording is reached		For example, number 5
Press the enter button		DIGifactor club 6x2,5Kw loads the required scene

The display will flash to indicate the request is unconfirmed; to escape at this point press the **menu** button

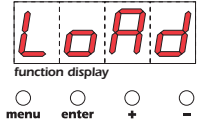
Press the enter button		To confirm your selection
-------------------------------	-------------------------------------------------------------------------------------	---------------------------

From this point **DIGifactor club 6x2,5Kw** will output the levels as previously recorded and the address display will include a decimal point, indicating a pre-recorded scene is currently being outputted.

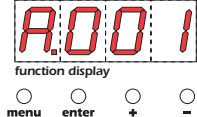
Indication that a pre-recorded scene is currently operational		Note the decimal point between the A and the DMX address
---------------------------------------------------------------	-------------------------------------------------------------------------------------	----------------------------------------------------------

NOTE: The pre-recorded scenes may be played back sequentially in the event of temporary control console failure.

NOTE: Pre-programmed scenes played back by the **DIGifactor club 6x2,5Kw** are faded in to avoid abrupt lighting changes on-stage.

9.3.11. Switching off pre-recorded scenes

Pre-recorded scenes may be switched off when no longer required.

ATTENTION! the following procedure will not erase the scene, it will simply de-activate it until future use.

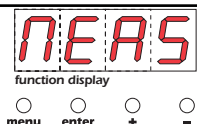
Power up DIGifactor club 6x2,5Kw		DIGifactor club 6x2,5Kw turns on
Press the menu button		Electronic display menu

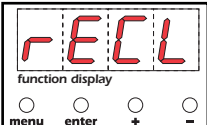
Press the + or - buttons until rECL is displayed		To recall the previously recorded scene
-----------------------------------------------------------------------	-----------------------------------------------------------------------------------	-----------------------------------------

Press the enter button		To confirm your selection
-------------------------------	-----------------------------------------------------------------------------------	---------------------------

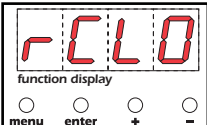
Press the + or - buttons until scene number 0 is displayed		Scene 0 is displayed, non-modifiable
---------------------------------------------------------------------------------	-----------------------------------------------------------------------------------	---------------------------------------------

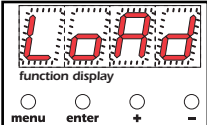
Press the enter button		DIGifactor club 6x2,5Kw loads the scene
-------------------------------	-----------------------------------------------------------------------------------	------------------------------------------------

The display will flash, indicating the need for confirmation; to escape at this point press the **menu** button

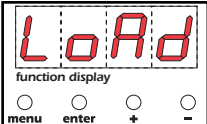
Press the enter button		To confirm your selection
-------------------------------	-----------------------------------------------------------------------------------	---------------------------

From this point **DIGifactor club 6x2,5Kw** ceases to output the levels of the pre-recorded scene. Note that the address display no longer has a decimal point present

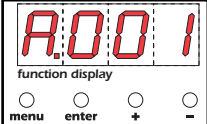
Indicating the absence of a pre-recorded scene		Note the decimal point between the A and the DMX address has switched off
------------------------------------------------	-----------------------------------------------------------------------------------	---------------------------------------------------------------------------

For your convenience we have included the following table which will allow you to note down any function changes you may make.

Tabella riepilogativa dei settaggi funzionali

CH	PrEH	SEtv	FUnC	CUrv
CH01			<input type="checkbox"/> cdiM <input type="checkbox"/> ScH0 <input type="checkbox"/> ScH1	<input type="checkbox"/> Strd <input type="checkbox"/> Lin
CH02			<input type="checkbox"/> cdiM <input type="checkbox"/> ScH0 <input type="checkbox"/> ScH1	<input type="checkbox"/> Strd <input type="checkbox"/> Lin
CH03			<input type="checkbox"/> cdiM <input type="checkbox"/> ScH0 <input type="checkbox"/> ScH1	<input type="checkbox"/> Strd <input type="checkbox"/> Lin
CH04			<input type="checkbox"/> cdiM <input type="checkbox"/> ScH0 <input type="checkbox"/> ScH1	<input type="checkbox"/> Strd <input type="checkbox"/> Lin
CH05			<input type="checkbox"/> cdiM <input type="checkbox"/> ScH0 <input type="checkbox"/> ScH1	<input type="checkbox"/> Strd <input type="checkbox"/> Lin
CH06			<input type="checkbox"/> cdiM <input type="checkbox"/> ScH0 <input type="checkbox"/> ScH1	<input type="checkbox"/> Strd <input type="checkbox"/> Lin
CH07			<input type="checkbox"/> cdiM <input type="checkbox"/> ScH0 <input type="checkbox"/> ScH1	<input type="checkbox"/> Strd <input type="checkbox"/> Lin
CH08			<input type="checkbox"/> cdiM <input type="checkbox"/> ScH0 <input type="checkbox"/> ScH1	<input type="checkbox"/> Strd <input type="checkbox"/> Lin
CH09			<input type="checkbox"/> cdiM <input type="checkbox"/> ScH0 <input type="checkbox"/> ScH1	<input type="checkbox"/> Strd <input type="checkbox"/> Lin
CH10			<input type="checkbox"/> cdiM <input type="checkbox"/> ScH0 <input type="checkbox"/> ScH1	<input type="checkbox"/> Strd <input type="checkbox"/> Lin
CH11			<input type="checkbox"/> cdiM <input type="checkbox"/> ScH0 <input type="checkbox"/> ScH1	<input type="checkbox"/> Strd <input type="checkbox"/> Lin
CH12			<input type="checkbox"/> cdiM <input type="checkbox"/> ScH0 <input type="checkbox"/> ScH1	<input type="checkbox"/> Strd <input type="checkbox"/> Lin
rECL				
	<input type="checkbox"/> rCL1		BCUP	Prot
	<input type="checkbox"/> rCL2		<input type="checkbox"/> bC 1	<input type="checkbox"/> Pr 1
	<input type="checkbox"/> rCL3		<input type="checkbox"/> bC 2	<input type="checkbox"/> Pr 2
	<input type="checkbox"/> rCL4		<input type="checkbox"/> bC 3	<input type="checkbox"/> oFF
	<input type="checkbox"/> rCL5		<input type="checkbox"/> bC 4	
	<input type="checkbox"/> rCL6		<input type="checkbox"/> bC 5	
	<input type="checkbox"/> rCL7		<input type="checkbox"/> bC 6	
	<input type="checkbox"/> rCL8		<input type="checkbox"/> bC 7	
	<input type="checkbox"/> rCL9		<input type="checkbox"/> bC 8	
			<input type="checkbox"/> bC 9	
			<input type="checkbox"/> oFF	

Tabella riepilogativa dei settaggi funzionali

CH	PrEH	SEtv	FUnC	CUrv
CH01			<input type="checkbox"/> cdiM <input type="checkbox"/> ScH0 <input type="checkbox"/> ScH1	<input type="checkbox"/> Strd <input type="checkbox"/> Lin
CH02			<input type="checkbox"/> cdiM <input type="checkbox"/> ScH0 <input type="checkbox"/> ScH1	<input type="checkbox"/> Strd <input type="checkbox"/> Lin
CH03			<input type="checkbox"/> cdiM <input type="checkbox"/> ScH0 <input type="checkbox"/> ScH1	<input type="checkbox"/> Strd <input type="checkbox"/> Lin
CH04			<input type="checkbox"/> cdiM <input type="checkbox"/> ScH0 <input type="checkbox"/> ScH1	<input type="checkbox"/> Strd <input type="checkbox"/> Lin
CH05			<input type="checkbox"/> cdiM <input type="checkbox"/> ScH0 <input type="checkbox"/> ScH1	<input type="checkbox"/> Strd <input type="checkbox"/> Lin
CH06			<input type="checkbox"/> cdiM <input type="checkbox"/> ScH0 <input type="checkbox"/> ScH1	<input type="checkbox"/> Strd <input type="checkbox"/> Lin
CH07			<input type="checkbox"/> cdiM <input type="checkbox"/> ScH0 <input type="checkbox"/> ScH1	<input type="checkbox"/> Strd <input type="checkbox"/> Lin
CH08			<input type="checkbox"/> cdiM <input type="checkbox"/> ScH0 <input type="checkbox"/> ScH1	<input type="checkbox"/> Strd <input type="checkbox"/> Lin
CH09			<input type="checkbox"/> cdiM <input type="checkbox"/> ScH0 <input type="checkbox"/> ScH1	<input type="checkbox"/> Strd <input type="checkbox"/> Lin
CH10			<input type="checkbox"/> cdiM <input type="checkbox"/> ScH0 <input type="checkbox"/> ScH1	<input type="checkbox"/> Strd <input type="checkbox"/> Lin
CH11			<input type="checkbox"/> cdiM <input type="checkbox"/> ScH0 <input type="checkbox"/> ScH1	<input type="checkbox"/> Strd <input type="checkbox"/> Lin
CH12			<input type="checkbox"/> cdiM <input type="checkbox"/> ScH0 <input type="checkbox"/> ScH1	<input type="checkbox"/> Strd <input type="checkbox"/> Lin
		rECL	BCUP	Prot
		<input type="checkbox"/> rCL1	<input type="checkbox"/> bC 1	<input type="checkbox"/> Pr 1
		<input type="checkbox"/> rCL2	<input type="checkbox"/> bC 2	<input type="checkbox"/> Pr 2
		<input type="checkbox"/> rCL3	<input type="checkbox"/> bC 3	<input type="checkbox"/> oFF
		<input type="checkbox"/> rCL4	<input type="checkbox"/> bC 4	
		<input type="checkbox"/> rCL5	<input type="checkbox"/> bC 5	
		<input type="checkbox"/> rCL6	<input type="checkbox"/> bC 6	
		<input type="checkbox"/> rCL7	<input type="checkbox"/> bC 7	
		<input type="checkbox"/> rCL8	<input type="checkbox"/> bC 8	
		<input type="checkbox"/> rCL9	<input type="checkbox"/> bC 9	
			<input type="checkbox"/> oFF	

Tabella riepilogativa dei settaggi funzionali

CH	PrEH	SEtv	FUnC	CUrv
CH01			<input type="checkbox"/> cdiM <input type="checkbox"/> ScH0 <input type="checkbox"/> ScH1	<input type="checkbox"/> Strd <input type="checkbox"/> Lin
CH02			<input type="checkbox"/> cdiM <input type="checkbox"/> ScH0 <input type="checkbox"/> ScH1	<input type="checkbox"/> Strd <input type="checkbox"/> Lin
CH03			<input type="checkbox"/> cdiM <input type="checkbox"/> ScH0 <input type="checkbox"/> ScH1	<input type="checkbox"/> Strd <input type="checkbox"/> Lin
CH04			<input type="checkbox"/> cdiM <input type="checkbox"/> ScH0 <input type="checkbox"/> ScH1	<input type="checkbox"/> Strd <input type="checkbox"/> Lin
CH05			<input type="checkbox"/> cdiM <input type="checkbox"/> ScH0 <input type="checkbox"/> ScH1	<input type="checkbox"/> Strd <input type="checkbox"/> Lin
CH06			<input type="checkbox"/> cdiM <input type="checkbox"/> ScH0 <input type="checkbox"/> ScH1	<input type="checkbox"/> Strd <input type="checkbox"/> Lin
CH07			<input type="checkbox"/> cdiM <input type="checkbox"/> ScH0 <input type="checkbox"/> ScH1	<input type="checkbox"/> Strd <input type="checkbox"/> Lin
CH08			<input type="checkbox"/> cdiM <input type="checkbox"/> ScH0 <input type="checkbox"/> ScH1	<input type="checkbox"/> Strd <input type="checkbox"/> Lin
CH09			<input type="checkbox"/> cdiM <input type="checkbox"/> ScH0 <input type="checkbox"/> ScH1	<input type="checkbox"/> Strd <input type="checkbox"/> Lin
CH10			<input type="checkbox"/> cdiM <input type="checkbox"/> ScH0 <input type="checkbox"/> ScH1	<input type="checkbox"/> Strd <input type="checkbox"/> Lin
CH11			<input type="checkbox"/> cdiM <input type="checkbox"/> ScH0 <input type="checkbox"/> ScH1	<input type="checkbox"/> Strd <input type="checkbox"/> Lin
CH12			<input type="checkbox"/> cdiM <input type="checkbox"/> ScH0 <input type="checkbox"/> ScH1	<input type="checkbox"/> Strd <input type="checkbox"/> Lin
		rECL	BCUP	Prot
		<input type="checkbox"/> rCL1	<input type="checkbox"/> bC 1	<input type="checkbox"/> Pr 1
		<input type="checkbox"/> rCL2	<input type="checkbox"/> bC 2	<input type="checkbox"/> Pr 2
		<input type="checkbox"/> rCL3	<input type="checkbox"/> bC 3	<input type="checkbox"/> oFF
		<input type="checkbox"/> rCL4	<input type="checkbox"/> bC 4	
		<input type="checkbox"/> rCL5	<input type="checkbox"/> bC 5	
		<input type="checkbox"/> rCL6	<input type="checkbox"/> bC 6	
		<input type="checkbox"/> rCL7	<input type="checkbox"/> bC 7	
		<input type="checkbox"/> rCL8	<input type="checkbox"/> bC 8	
		<input type="checkbox"/> rCL9	<input type="checkbox"/> bC 9	
			<input type="checkbox"/> oFF	

10. Remote back-up scene restoration

DIGifactor club 6x2,5Kw allows a remote signal to be used to restore a back-up scene. This may be useful in case a problem occurs with the controller normally used with the dimmer.

The scene should be recorded as described in section 9.3.7 and may be activated as described below.

1) Remove the 4 screws (A) which affix the top cover (B).

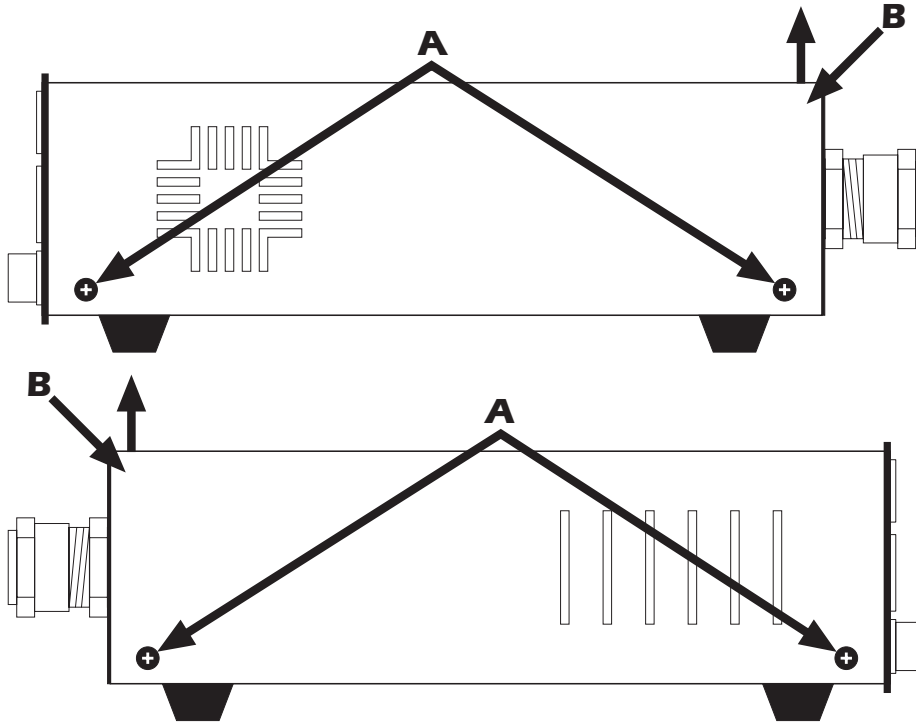

2) Locate the clamp (C).

3) Connect a two pole switch, as shown below.

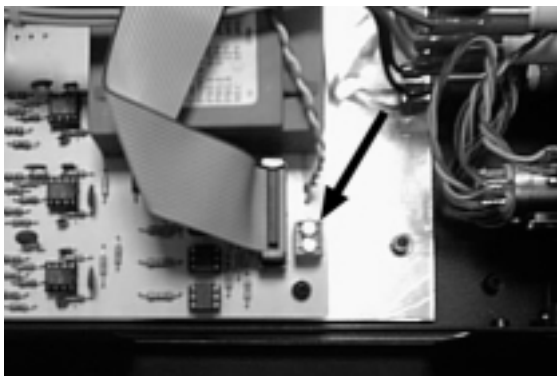
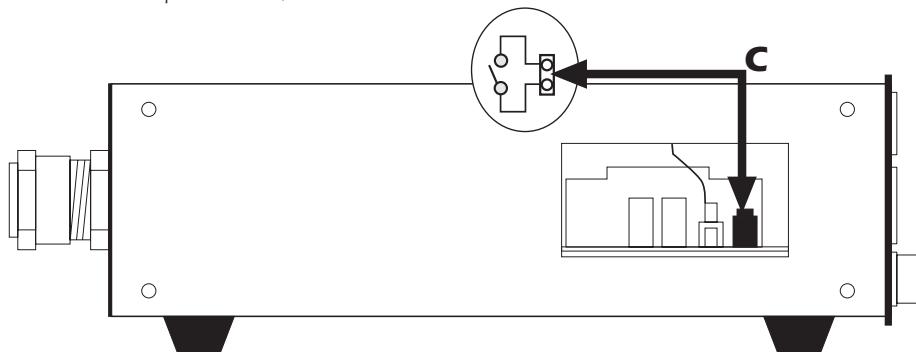

4) If the switch is open **DIGifactor club 6x2,5Kw** operates normally; if the switch is closed, the scene previously saved as the back-up will be activated.

There is a delay of some 10 seconds prior to the scene being activated, so as to avoid an abrupt change to the lighting state in operation.

A dot will flash in the display to indicate that the back-up scene is activated.

5) To deactivate the back-up scene, simply switch the circuit to open once again.

NOTE 1: the back-up scene takes absolute precedence, any 0-10V or DMX signal is over-riden

NOTE 2: back-up levels take priority over the recalled scene

11. Error messages

DIGifactor club 6x2,5Kw assists the installer and user in determining the reasons for possible failures; its memory contains the following error messages.

In the majority of cases, it may be advisable to seek the advice of an individual who has experience with the causes of errors which are described below

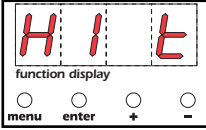
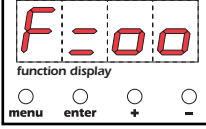
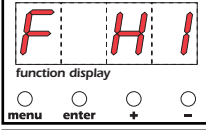
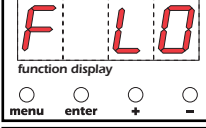
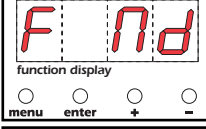
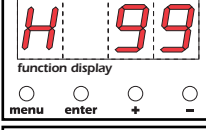
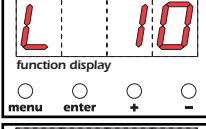
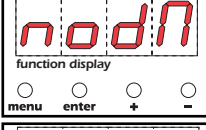
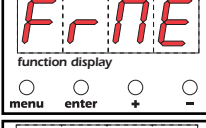
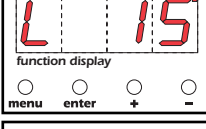
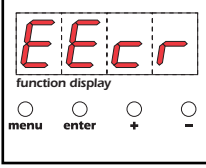
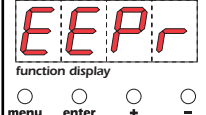
	<p>The internal temperature has exceeded 65°. The display will flash to indicate an abnormal state. DIGifactor club 6x2,5Kw can continue to operate but is in danger of being damaged; adequate ventilation must be provided to resolve this problem</p>
	<p>An internal hardware failure has occurred which is causing the unit to be unable to determine the operating frequency of 50-60 Hz. This message appears upon start up. Being a hardware problem, the unit will need to be referred to an authorised coemar service centre.</p>
	<p>The frequency measured at start up exceeds 62 Hz DIGifactor club 6x2,5Kw auto sets to 60 Hz; the power supply frequency problem will need to be investigated and the problem rectified in the short term.</p>
	<p>The frequency measured at start up is below 48 Hz DIGifactor club 6x2,5Kw auto sets to 50 Hz; the power supply frequency problem will need to be investigated and the problem rectified in the short term.</p>
	<p>The frequency measured at start up falls between 52 and 58 Hz, and is therefore not standard. DIGifactor club 6x2,5Kw auto sets to 50 Hz; the power supply frequency problem will need to be investigated and the problem rectified in the short term.</p>
	<p>The frequency, as measured during a electronic menu function exceeds the range of the unit's measurement capacity, which is between 10 and 99 Hz This condition can only be detected by a electronic menu function. The problem will need to be rectified in the short term.</p>
	<p>The frequency, as measured during a electronic menu function falls below the range of the unit's measurement capacity, which is between 10 and 99 Hz This condition can only be detected by a electronic menu function. The problem will need to be rectified in the short term.</p>
	<p>No DMX signal present or not standard DMX 512. Check all DMX connections and the DMX 512 controller which may be switched off</p>
	<p>The number of channels being transmitted to the DIGifactor club 6x2,5Kw are below those indicated by its DMX address. The DMX signal cannot be interpreted correctly as it is incomplete. The dimmer requires more channels of DMX to be sent; consult your controller's manual</p>
	<p>The temperature is measured at below 15°C and is below the capacity of the unit to measure. This error will not compromise the correct functioning of the dimmer, however, it may indicate that the thermal sensor may have shifted its position in the dimmer's internals, perhaps during transportation. A check of this is recommended.</p>
	<p>An error has occurred in the EEPROM data. This error message will be shown immediately after powering up the unit. In this situation DIGifactor club 6x2,5Kw will attempt to rectify the error itself; success will depend upon the seriousness of the error. DIGifactor club 6x2,5Kw will reset itself after the error has been corrected although it should be noted that data entered via the menu functions may have been lost. Attention! default settings may be incompatible with any switching circuits connected; if this condition is encountered, ensure all functions are returned to your settings.</p>
	<p>EEPROM access/reading error. DIGifactor club 6x2,5Kw will operate only at the factory presets, or any changes made via the menu functions. This indicates that the EEPROM is defective or missing. Attention! default settings may be incompatible with any switching circuits connected; if this occurs, ensure all functions are returned to your settings. Contact your coemar service centre</p>

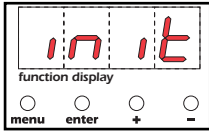

The EEPROM is being re-initialised. This may occur if the EEPROM is new or has been erased completely. It is being re-initialised with the unit's default settings.

12. Maintenance fuse replacement

The dimmer utilises 6 fuses for load protection located adjacent to the load sockets.

The indicators associated with each channel will indicate a blown fuse; this indicator is easily seen.

Indicators will switch on to indicate a blown fuse, replace each fuse with one of similar dimensions and physical characteristics: T10A ceramic 6,2 X 32mm.

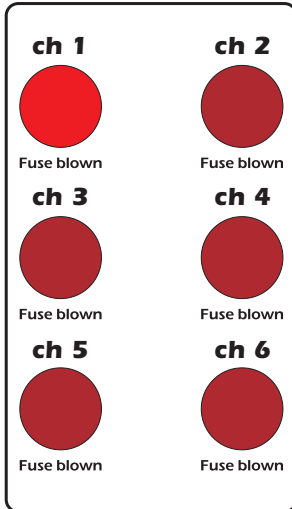

A lamp won't come on

A brief check-list of possible remedies to this situation.

- 1) Check the circuit indicator to see if it shows that a fuse is blown.
- 2) Check the fixture's lamp is not blown and it is operating normally.
- 3) Check the controller to isolate the dimmer as the cause of the problem.
- 4) Check the channel monitor on the front panel
- 5) Perform the test procedure as described in section 9.1.1.
- 6) Reset the memory of the EEPROM as indicated in section 9.3.6.
- 7) Following this, re-test the unit as described in section 9.1.1.

If, after this point, the dimmer is still not generating the required output, refer the unit to your authorised **coemar** service centre for assistance with your **DIGifactor club 6x2,5Kw**.

Replacing a triac

- 1) Remove the 4 screws (A) which affix the top cover (B).

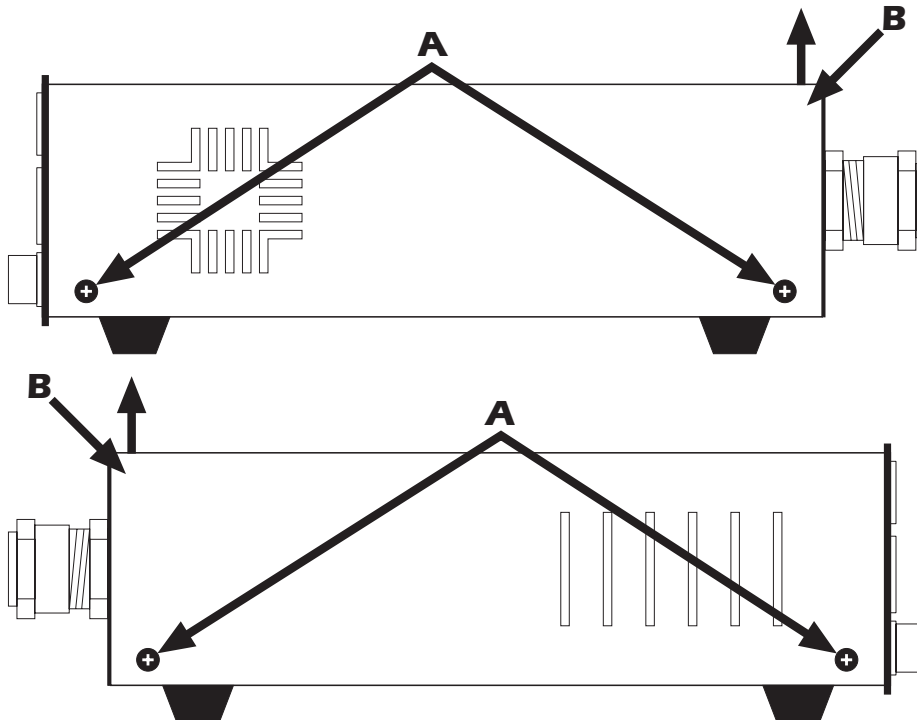

- 2) Locate the faulty triacs replacing each as shown with one of the same type: (BTA26-600B)

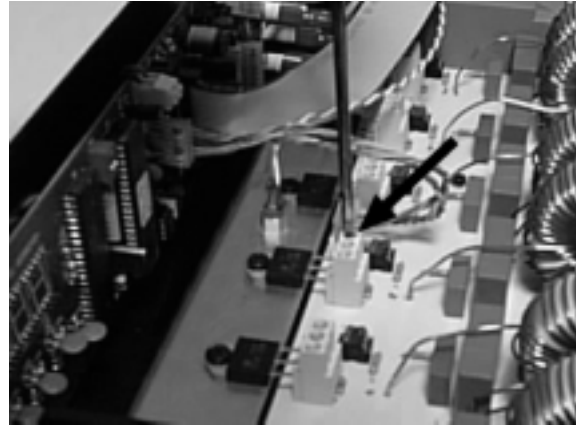

3) Test the unit is functioning correctly and replace all components and covers.

Periodic cleaning

The fan and air passages should be inspected and cleaned at least every 12 weeks; this period of time may be shorter depending upon the unit's operating conditions.

To effect this cleaning use a common brush, vacuum cleaner, or air compressor.

If necessary, do not hesitate to perform this cleaning more frequently than recommended.

Electronic components.

Check all electrical connections, in particular the earth connection and all removeable connectors.

Press all connectors firmly, if necessary, re-affixing them as they were originally.

13. Spare parts

All the components of the **DIGifactor club 6x2,5Kw** are available as spare parts from your authorised **coemar** service centre.

To assist us in providing you with prompt and accurate service, carefully specify the model and serial number of the unit, and the spare parts which you require.



coemar spa

manuale istruzioni

DIGifactor club 6x2,5Kw